

GSE Ground System

Dimensionnement panneaux 2021

Largeurs de modules jusqu'à 1350 mm

Présenté le : 29/03/21

Ground System – Dimensionnement Barre Z

➤ Barre Z v2021:

Mai 2021

- Nouvelle taille : **2,32 m**
- Trous continus pour faciliter le positionnement des modules et s'adapter aux largeurs jusqu'à 1150mm.

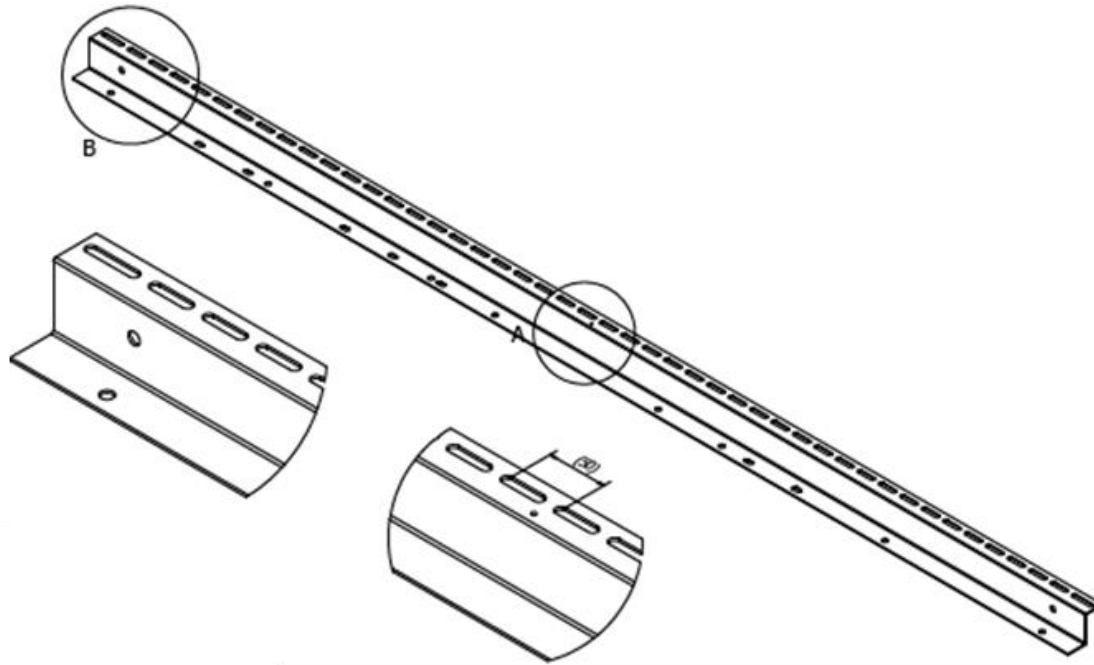

Ground System – Dimensionnement Barre Z

➤ Kits 2, 4 et 6 panneaux avec la Barre Z v2021:

Mai 2021

1140

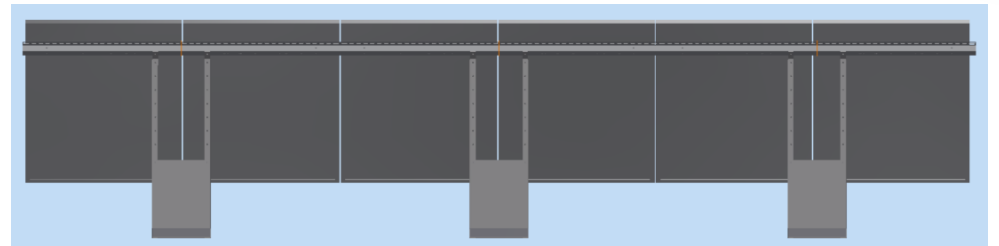
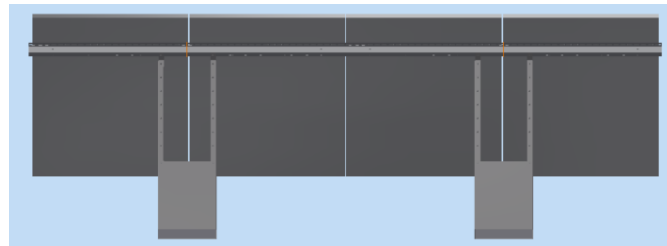
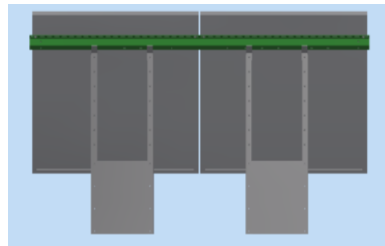

1052

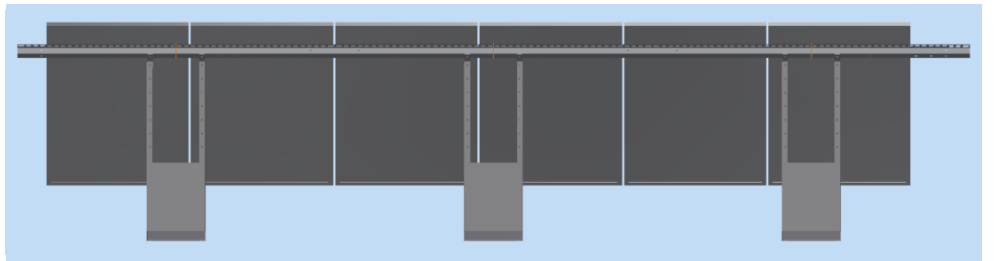
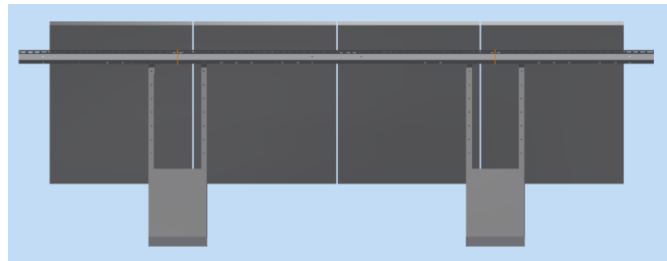
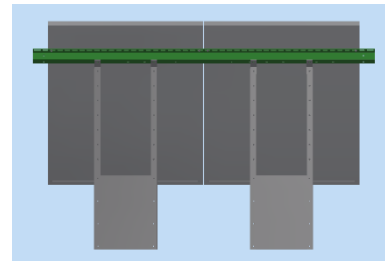

992

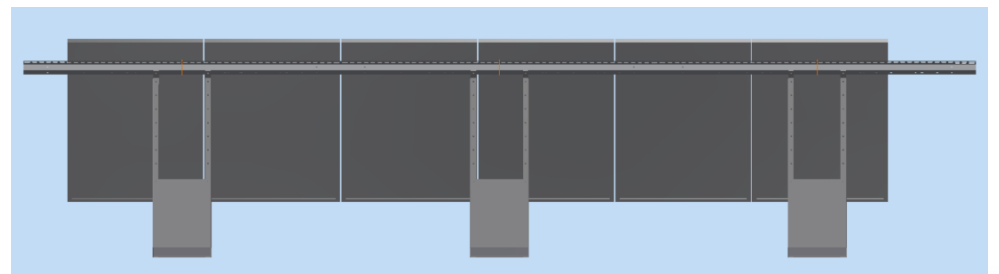
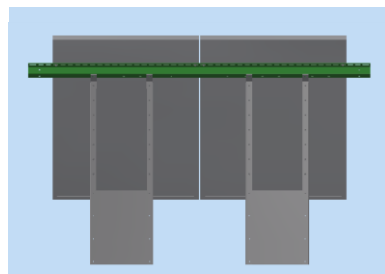

Ground System – Dimensionnement rail **On-Roof**

➤ On-Roof - Kit 2 panneaux

- Largeur de panneau ≤ 1000
 - Rails 2,10m : 2
 - Rails 3,15m : 0



- $1000 < \text{Largeur de panneau}$
 - Rails 2,10m : 0
 - Rails 3,15m : 2

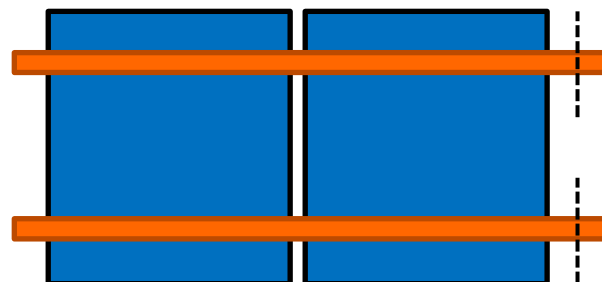

Ground System – Dimensionnement rail **On-Roof**

➤ On-Roof - Kit 4 panneaux

- Largeur de panneau ≤ 1010
 - Rails 2,10m : 4
 - Rails 3,15m : 0
- $1010 < \text{Largeur de panneau} \leq 1275$
 - Rails 2,10m : 2
 - Rails 3,15m : 2
- $1275 < \text{Largeur de panneau}$
 - Rails 2,10m : 0
 - Rails 3,15m : 4

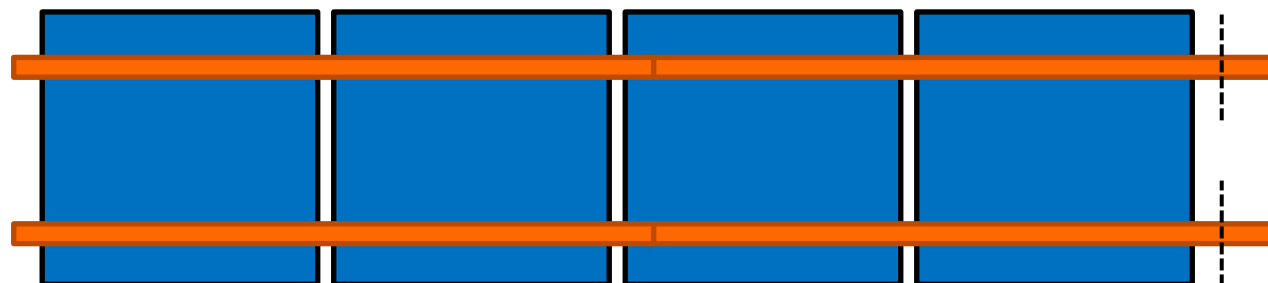
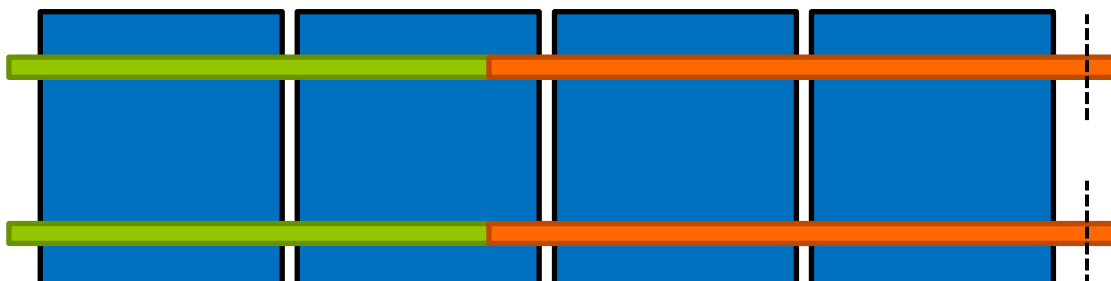

Ground System – Dimensionnement rail **On-Roof**

➤ On-Roof - Kit 6 panneaux

- Largeur de panneau ≤ 1015
 - Rails 2,10m : 6
 - Rails 3,15m : 0

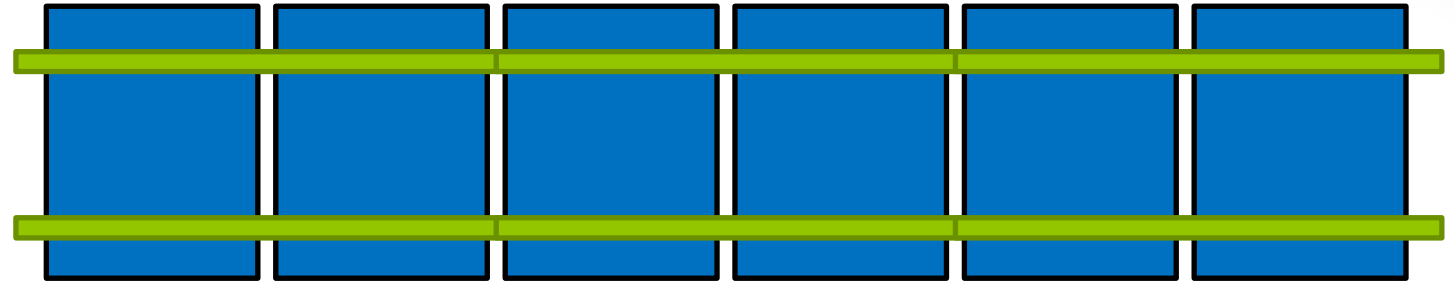

- $1015 < \text{Larg. panneau} \leq 1190$
 - Rails 2,10m : 4
 - Rails 3,15m : 2



- $1190 < \text{Larg. Panneau}$
 - Rails 2,10m : 2
 - Rails 3,15m : 4

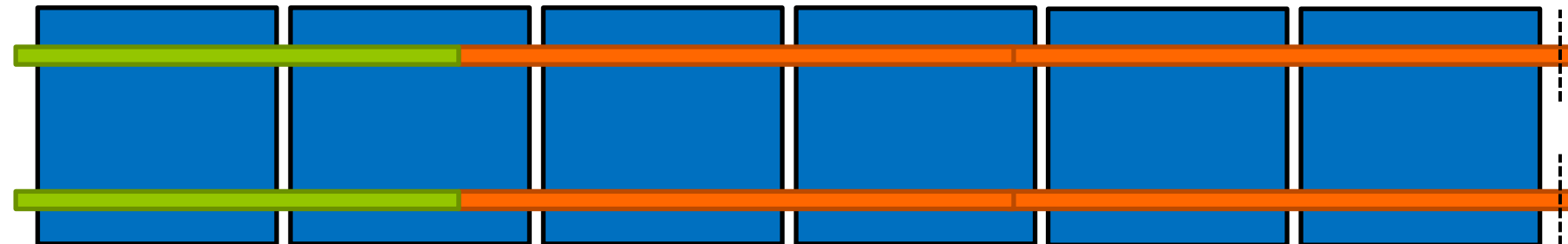

Ground System – Dimensionnement rail **On-Roof**

➤ On-Roof - Kit 2 panneaux

Mai 2021

- Largeur de panneau ≤ 1150
 - Rails **2,40m** : 2

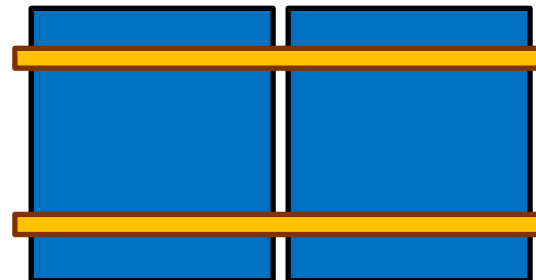

- **1150 < Largeur de panneau**
 - **Rails 3,15m** : 2

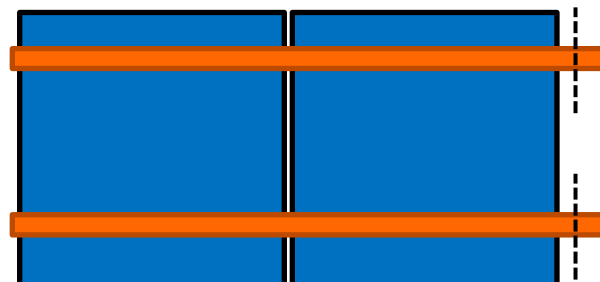

Ground System – Dimensionnement rail **On-Roof**

➤ On-Roof - Kit 4 panneaux

Mai 2021

- Largeur de panneau ≤ 1160
 - Rails **2,40m** : 4

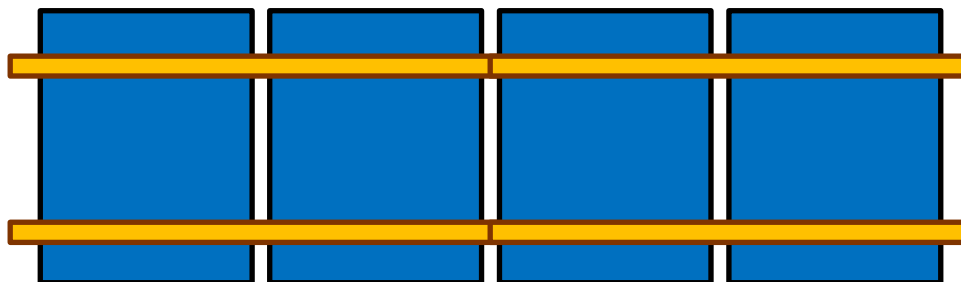

- **1160 < Largeur de panneau**
 - **Rails 2,40m** : 2
 - **Rails 3,15m** : 2

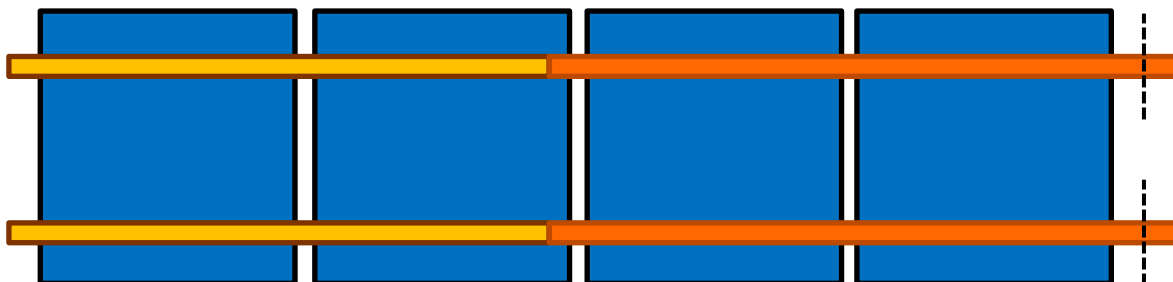

Ground System – Dimensionnement rail **On-Roof**

➤ On-Roof - Kit 6 panneaux

Mai 2021

- Largeur de panneau ≤ 1165
 - Rails 2,40m : 6



- $1165 < \text{Larg. panneau} \leq 1290$
 - Rails 2,40m : 4
 - Rails 3,15m : 2



- $1290 < \text{Larg. panneau}$
 - Rails 2,40m : 2
 - Rails 3,15m : 4

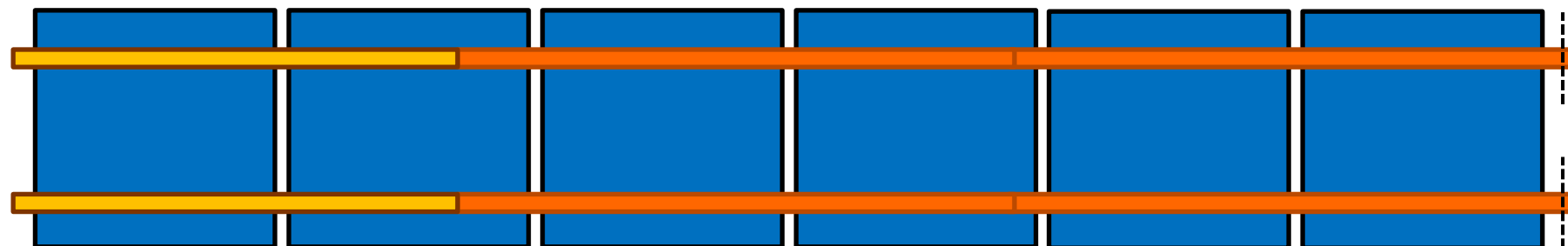

A votre disposition pour vous assister :

SUPPORT TECHNIQUE

Email : technical.support@gseintegration.com

Hotline technique : +33.1.70.32.08.05

ADV : +33.1.49.48.14.51

Florent PRUDHOMME

Responsable Développement – Systèmes de montage

Mobile : +33.6.98.04.06.26

Email : florent.prudhomme@gseintegration.fr

Théophile DELALOY

Directeur commercial

Mobile : +33.6.59.41.56.03

Email : theophile.delaloy@gseintegration.fr